



**RESILIENT SEATED**  
Butterfly Valves

# INDEX



## Butterfly Valves

Page

<b>Series 20</b> wafer	1"-20" (25mm-500mm)	150 psi (10.3 Bar)	<b>8</b>
<b>Series 21</b> lug	2"-20" (50mm-500mm)	150 psi (10.3 Bar)	<b>8</b>
<b>Series 22</b> wafer	2"-20" (50mm-500mm)	150 psi (10.3 Bar)	<b>10</b>
<b>Series 23</b> lug	2"-24" (50mm-600mm)	150 psi (10.3 Bar)	<b>10</b>
<b>Series 30</b> wafer	2"-12" (50mm-300mm)	175 psi (12 Bar)	<b>12</b>
	14"-20" (350mm-500mm)	150 psi (10.3 Bar)	<b>12</b>
<b>Series 31</b> lug	2"-12" (50mm-300mm)	175 psi (12 Bar)	<b>12</b>
	14"-20" (350mm-500mm)	150 psi (10.3 Bar)	<b>12</b>
<b>Series 31H</b> lug	2"-20" (50mm-500mm)	250 psi (17.2 Bar)	<b>13</b>
<b>Series 31U</b> lug	2"-20" (50mm-500mm)	285 psi (20 Bar)	<b>14</b>
<b>Series 3A</b> double flanged	2"-12" (50mm-300mm)	175 psi (12 Bar)	<b>16</b>
	14"-20" (350mm-500mm)	150 psi (10.3 Bar)	<b>16</b>
<b>Series 3AH</b> double flanged	2"-20" (50mm-500mm)	250 psi (17.2 Bar)	<b>16</b>
<b>Series 32</b> wafer	22"-36" (550mm-900mm)	75 psi (5.2 Bar)	<b>18</b>
<b>Series 33</b> wafer	22"-36" (550mm-900mm)	150 psi (10.3 Bar)	<b>18</b>
<b>Series 35</b> double flanged	22"-120" (550mm-3000mm)	75 psi (5.2 Bar)	<b>18</b>
<b>Series 36</b> double flanged	22"-120" (550mm-3000mm)	150 psi (10.3 Bar)	<b>18</b>
<b>Series 36H</b> double flanged	22"-60" (550mm-1500mm)	232 psi (16 Bar)	<b>20</b>
<b>Series 35F</b> double flanged	32"-60" (800mm-1500mm)	75 psi (5.2 Bar)	<b>21</b>

## Actuators & Accessories

22



# **Bray** CONTROLS



## INTRODUCTION

Through years of field application experience, research and development, we have designed products that meet the stringent requirements of today's flow control industry. Bray has earned a reputation for excellence by creating products of superior value and quality, providing personalized customer service and on-time deliveries. Our success has always been the direct result of our fully integrated range of butterfly valve and control products. Rugged and reliable, our products are engineered to provide years of trouble free service.

*Bray products are used in a wide range of industries worldwide including:*

- Chemical
- Beverage
- Brewing/Wine Making
- Pharmaceutical
- Food Processing
- Petroleum Refining & Oilfield
- Transportation
- Ultrapure Water
- Marine
- Pulp & Paper
- Mining
- Power/FGD
- Nuclear Power
- Irrigation
- Water & Wastewater Treatment
- Textile
- Desalination
- Steel Production
- Sugar/Ethanol
- HVAC

## PRODUCT QUALITY & PRECISION

Bray manufacturing facilities are certified to ISO 9001 quality standards, assuring product quality, precision manufacturing and internal process integrity. The basis for Bray Controls high level of quality assurance are the quality control guidelines and procedures submitted, reviewed and approved in accordance with criteria established within ISO 9001:2000 and EU Directives.

*“Bray Controls is focused on and committed to meeting the expectations and needs of our customers while continually improving the effectiveness of our quality management.”*

- All Bray valves are pressure tested to 110% of rated pressure to assure bubble tight shutoff.
- All Actuators are calibrated and cycle tested before shipment. Pneumatic actuators are also pressure tested to assure no leakage.
- Material Traceability - Certification is provided for all valves upon request for all pressure retaining components.
- Positive Material Identification - All materials are subjected to PMI testing to verify material traceability certificate.

*A complete listing of approvals & certifications can be found at [www.braycontrols.com](http://www.braycontrols.com).*



# DESIGN BENEFITS

## 1 ISOLATION FROM LINE MEDIA

achieved in two fundamental design concepts:

**A. INTERNAL DISC/STEM CONNECTION** Bray offers three disc-to-stem connections: Double 'D', Splined, and Double Key. These internal, non-wetted connections eliminate exposed external disc-to-stem connections such as screws or taper pins.

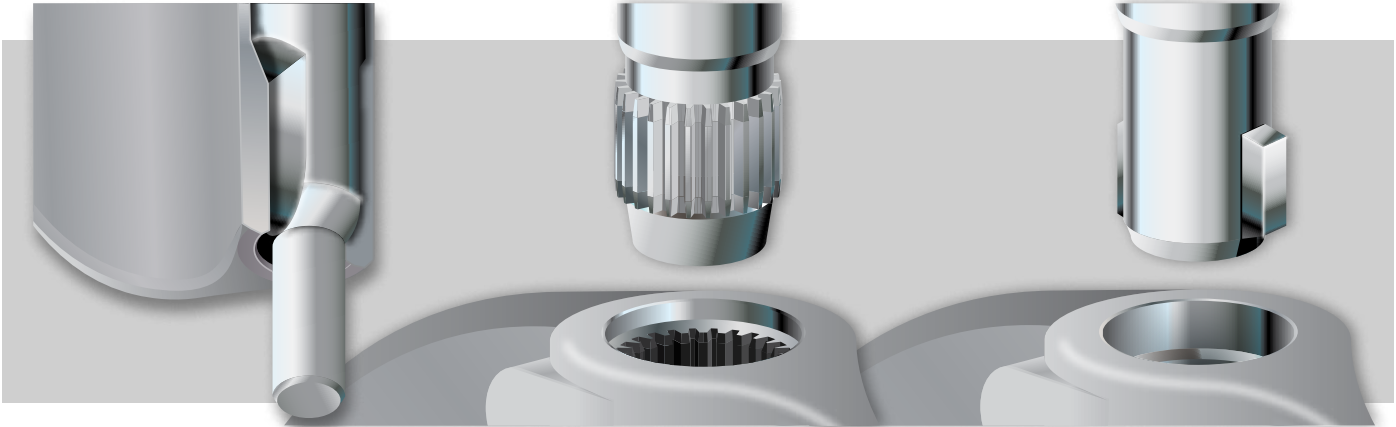

**1. Double D:** precision machined flats on the stem and in the disc.  
Sizes 2" – 20" (50mm–500mm)

**2. Spline:** male splines in the stem and female in the disc.  
Standard Sizes 22" – 48" (550mm–1200mm)  
Selected Sizes 54" – 120" (1400mm–3000mm)

**3. Double Keyed:** keyways machined into disc matching keys in the stem  
Selected Sizes 54" – 120" (1400mm–3000mm)

Disassembly of Bray's internal connection is performed by simply pulling the stem out of the disc. Bray's precision machining of the disc and the stem connection minimizes hysteresis and produces maximum strength engagements. All stem designs incorporate a blow-out proof feature.

**B. SEAT DESIGN** Bray's seat design provides complete isolation of flowing media from the body and stem by a totally encasing design. Designed to seal with slip-on or weld-neck flanges.

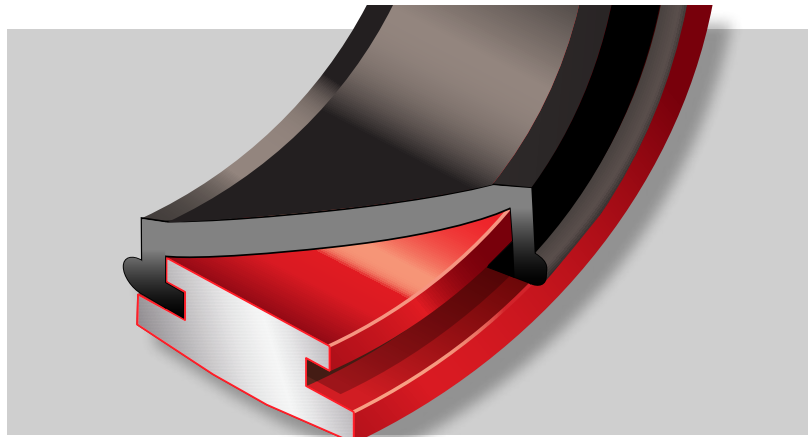

**Tongue-and-groove**

## 2 INTERNATIONAL COMPATIBILITY

Valve mounting top flanges meet ISO 5211 standards for direct mounting of manual operators and power actuators. All Bray valves have extended necks which allow for at least 2" piping insulation.



## 3 ACTUATOR MOUNTING

Due to a modular concept of design, all Bray actuators including Handles, Gear Operators, Pneumatic and Electric Actuators mount directly to Bray resilient seated valves. No brackets are required. This allows for simple installation in the field, minimizes possible misalignment and reduces overall height.

# EXTERNAL COATING OPTIONS

## 1 POLYESTER BODY COATING

Bray's standard product offers valve bodies with a polyester coating, providing excellent corrosion and wear resistance to the valve's surface. The Bray polyester coating is a hard, gloss red finish.

### **Chemical Resistant**

Resists a broad range of chemicals including dilute acids and alkalis, petroleum solvents, alcohols, greases and oils. Also offers outstanding resistance to humidity and water.

### **Weatherability**

Resistant to ultra-violet radiation.

### **Abrasion Resistant**

Excellent resistance to abrasion.

### **Impact Resistant**

Withstands impact without chipping or cracking.

## 2 NYLON 11 COATING:

Nylon 11 also has superior corrosion resistance and has been used successfully in many applications such as water, cement, food and seawater.

### **Weatherability**

Bray's Nylon 11 coating has been salt spray tested in excess of 2000 hours and used in seawater immersion service for over 25 years without any deterioration of the coating resulting in no corrosion to the coated metal components.

### **Abrasion Resistant**

Excellent resistance to abrasion.

### **Impact Resistant**

Excellent - no chipping or cracking.

*Other customer specified coating materials are available.  
Please consult your local Bray representative  
for your specific application.*

## 3 SEACORR COATING:

FDA Epoxy pigmented with 316L Stainless Steel Flake available for corrosive environments as tested per ASTM B-117 salt spray test for 2000 hours.



# SEAT MATERIALS

## Seat Temperature Ranges

EPDM.....-20°F (-29°C) 250°F (121°C)  
BUNA-N.....0°F (-18°C) 212°F (100°C)

FKM.....0°F (-18°C) 400°F (204°C)  
Polyurethane.....-20°F (-29°C) 176°F (80°C)

## EPDM (Peroxide Cured)

EPDM is the abbreviated name for Ethylene Propylene Diene Monomer. In general industry, one may see other abbreviations or trade names used in lieu of EPDM such as EPT, Nordel, ECD, or EPR. Typically these are the same materials as EPDM.

EPDM is a standard seat material offered in Bray resilient-seated butterfly valves. It is the most universal and economical of seat materials offered by Bray; that is, it may be used in a wider range of applications than BUNA-N. Of important significance also is the fact all EPDM seat materials sold by Bray are Food Grade. Bray's EPDM Food Grade seats are perfectly suitable for sanitary applications as well as standard industrial uses. EPDM is also available as a covering for Series 20 discs.

## BUNA-N (Black & White)

BUNA-N is the commonly used name for Nitrile synthetic rubber. Nitrile is a copolymer of acrylonitrile and butadiene. BUNA-N is sometimes referred to as NBR, Nitrile, or Hycar. BUNA-N is an excellent general purpose seat material which is particularly suitable for hydrocarbon service. BUNA-N is a standard Bray seat material and is Food Grade; thus suitable for sanitary applications. Note, BUNA-N is also available as a covering for Series 20 disc stems.

## FKM

FKM is the ASTM D1418 designation for Fluorinated Hydrocarbon Elastomers (Fluoroelastomers) such as Viton® (DuPont). FKM has some outstanding characteristics such as improved acid, oil, and temperature resistance over standard seat materials.

## POLYURETHANE

Urethane seats are primarily used for their ability to resist abrasive wear. Urethane can be used on a reasonably broad range of services. Urethane will withstand severe impact, recover its original shape after distortion and resist abrasion better than other elastomers such as EPDM and BUNA-N.

*Seat material availability depends on valve size & series.  
Please consult your local Bray representative  
for your specific application.*



# SEAT MATERIALS

## Seat Temperature Ranges

PTFE-Lined EPDM (Standard)	-20°F (-29°C)	250°F (121°C)
PTFE-Lined EPDM (High-Temp)	-20°F (-29°C)	302°F (150°C)

Virgin PTFE & Conductive PTFE	0°F (-18°C)	392°F (200°C)
UHMWPE	0°F (-18°C)	185°F (85°C)



## PTFE LINED EPDM (Standard or High-temp)

PTFE lined EPDM seat consists of a PTFE liner which forms the faces and the flow way of the seat, and is molded on to an EPDM elastomer backing. Only the inert non-stick PTFE liner surface is exposed to the line media. The EPDM backing acts as a resilient support to the relatively rigid PTFE. These seats are generally used where BUNA-N and EPDM seats are not chemically suitable, especially in corrosive services.

## VIRGIN PTFE

All Bray PTFE seats and encapsulated discs are molded from pure, virgin PTFE material to the following specifications: thickness 3 mm, specific gravity 2.16, crystallinity 68%. PTFE's inherent molecular bonding strength gives an excellent chemical, high temperature and tear resistance. Sintered processed PTFE offers lower permeability than melt processed materials such as PFA. These properties combined with Bray's stringent material specifications provide optimum protection against permeation of the line media.

## CONDUCTIVE PTFE

Bray Conductive PTFE seats and discs are available for installation in areas of the plant where explosion protection is important. This material was designed to prevent harmful electrostatic discharge. For the ultimate in safety and reliability, Bray has combined electrostatic discharge protection and the excellent chemical resistance properties of PTFE. The conductive PTFE seat and the disc has a minimum thickness of 1/8" (3 mm), providing optimum protection against permeation of the line media.

## UHMWPE

UHMWPE seats and discs feature exceptional chemical resistance and are the ideal choice for highly abrasive chemical applications. The natural ability of the UHMWPE's high molecular weight to repel solids prevents in-line particles from damaging the valve's seat surfaces. An economical and high performance choice for abrasive chemical services.

*Seat material availability depends on valve size & series.  
Please consult your local Bray representative  
for your specific application.*

# SERIES 20/21 1"-20" (25mm-500mm)



## PRESSURE RATINGS

BIDIRECTIONAL BUBBLE-TIGHT SHUT-OFF Downstream Flanges/Disc in Closed Position			
Resilient Seated	Metal Disc/Stem	1-20" (25-500mm)	150 psi (10.3 Bar)
	Resilient Molded Disc/Stem	2-20" (50-500mm)	100 psi (7 Bar)
PTFE Seated	Metal Disc/Stem	2-20" (50-500mm)	150 psi (10.3 Bar)
	PTFE Molded Disc/Stem	2-20" (50-500mm)	100 psi (7 Bar)
DEAD-END SERVICE – Lug Bodies No Downstream Flanges/Disc in Closed Position			
All Valves		2-12" (50-300mm)	75 psi (5.2 Bar)
		14-20" (350-500mm)	50 psi (3.4 Bar)
BODY: 250 psi (17.2 Bar) CWP			

## VELOCITY LIMITS For On/Off Services:

Fluids 30 ft/sec (9 m/s)	Gases 175 ft/sec (54 m/s)
--------------------------	---------------------------

The Series 20/21 valve not only surpasses the high standards required in sanitary valve applications, and inherent flow characteristics and capabilities. Bray's Series 20 valve is a wafer version with flange locating holes, and the Series 21 is the companion lug version for dead-end service and other flange requirements.

- Sanitary & Chemical applications
- One-piece disc/stem
- High  $C_v$ , low pressure drop



**STEM BUSHING:** Non-corrosive, heavy duty acetal bushing absorbs actuator side thrust.

**STEM SEAL:** Double "U" cup seal design is self-adjusting and gives positive sealing in both directions and prevents external substances from entering the stem bore.

**DISC / STEM:** One-piece design. The disc edge is spherically machined and hand polished to produce a bubble-tight shut off, minimum torque, and longer seat life. The disc/stem design inherently provides complete protection from particle entrapment and bacterial decay, protection that is required for sanitary performance. For superior erosion and abrasion resistance, the one-piece disc/stem is fully encased in either EPDM or BUNA-N. The thin disc profile provides a much higher  $C_v$  (up to 50% greater than most through-stem designs) and greater pressure recovery, thus resulting in lower pressure drops and a more energy-efficient valve.

**PRIMARY & SECONDARY SEALS:** These seals prevent line media from coming in contact with the stem or body. *Primary Seal* is achieved by an interference fit of the molded seat flat with the disc hub. *Secondary Seal* is created because the stem diameter is greater than the diameter of the seat stem hole.

**SEAT:** Bray's tongue and groove seat design lowers torque and provides complete isolation of flowing media from the body. The seat also features a molded O-ring which eliminates the use of flange gaskets.

**BODY:** Two-piece wafer or lug style allows for ease of assembly and maintenance. Nylon 11 coating for excellent corrosion resistance is standard for 1"-8" valves and available on larger sizes upon request. Polyester coating is standard for 10"-20" bodies.



All Bray valves are pressure tested to 110% of rated pressure to assure bubble tight shutoff.

## STANDARD MATERIALS SELECTION

NAME	MATERIAL
------	----------

<b>Body</b>	Cast Iron
	Ductile Iron
	316 Stainless Steel
	Aluminum

<b>Disc/Stem</b>	<b>METAL:</b>
------------------	---------------

1" -12" One Piece Investment Cast	316 Stainless Steel
	Hastelloy® C-22
14" -20" Fabricated	316 Stainless Steel disc with 316 Stainless Steel stem
	Hastelloy® disc with Hastelloy® stem

<b>RUBBER MOLDED:</b>	
-----------------------	--

2" -12" One Piece Investment Cast	EPDM molded over one piece Stainless Steel disc/stem
	BUNA-N molded over one piece Stainless Steel disc/stem
14" -20" Fabricated	EPDM molded over Stainless Steel disc with Stainless Steel stem
	BUNA-N molded over Stainless Steel disc with Stainless Steel stem

<b>PTFE MOLDED:</b>	
---------------------	--

2" -12" One Piece Investment Cast	PTFE molded over one piece Stainless Steel disc/stem
-----------------------------------	--

<b>HALAR® COATED:</b>	
-----------------------	--

2" -12" Investment Cast	Halar® coated over one piece Stainless Steel disc/stem
	Halar® coated over Stainless Steel disc with Stainless Steel stem
14" -20" Fabricated	Halar® coated over Stainless Steel disc with Stainless Steel stem

<b>Seat</b>	BUNA-N – Food Grade
	EPDM – Food Grade
	FKM*
	White BUNA-N – Food Grade
	PTFE-Lined EPDM

Material availability depends on valve size & series. Other materials are available. Please consult your local Bray representative for your specific application.

\*FKM is the ASTM D1418 designation for Fluorinated Hydrocarbon Elastomers (also called Fluoroelastomers).

Halar® is a registered trademark of Ausimont U.S.A., Inc.

Hastelloy® is a registered trademark of Haynes International, Inc.

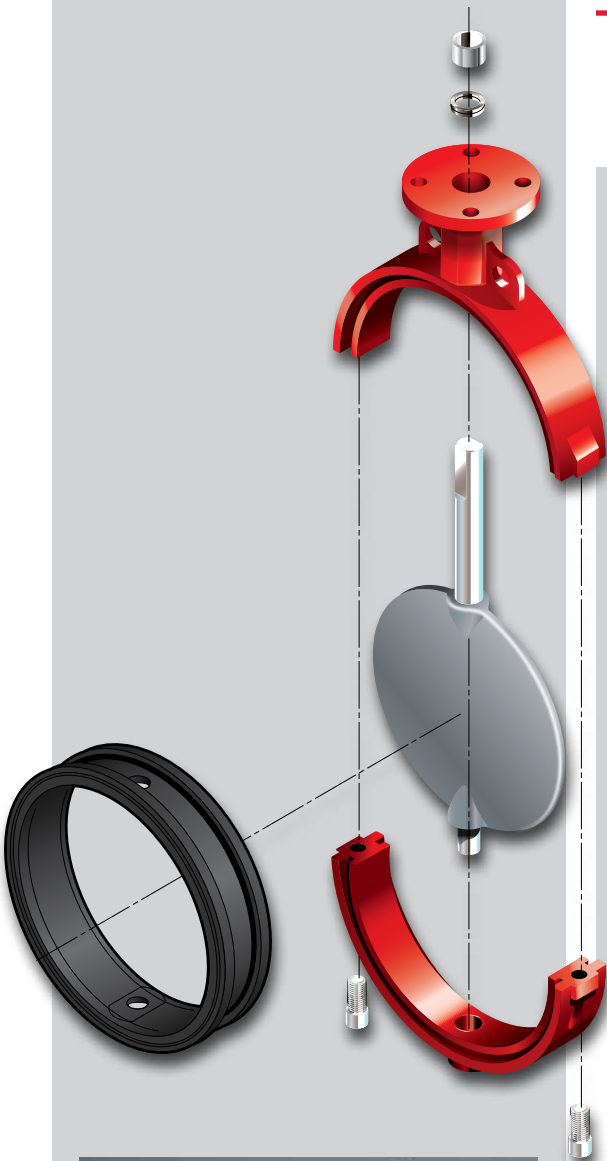

# SERIES 22/23 2"-24" (50mm-600mm)



## PRESSURE RATINGS

**BIDIRECTIONAL BUBBLE-TIGHT SHUT-OFF** Downstream Flanges/Disc in Closed Position

All Valves	2-24" (50-600mm)	150 psi (10.3 Bar)
------------	------------------	--------------------

**DEAD-END SERVICE – Lug Bodies** No Downstream Flanges/Disc in Closed Position

All Valves	2-12" (50-300mm)	75 psi (5.2 Bar)
	14-24" (350-600mm)	50 psi (3.4 Bar)

**BODY:** 250 psi (17.2 Bar) CWP

## VELOCITY LIMITS For On/Off Services:

**Fluids** 30 ft/sec (9 m/s)

**Gases** 175 ft/sec (54 m/s)

## TEMPERATURE RATINGS

**PTFE:** 0°F(-18°C) min. – 392°F(200°C) max

**UMMWPE:** 0°F(-18°C) min. – 185°F(85°C) max

Extensive field research and engineering have developed this state-of-the-art design which provides excellent shut off protection (bubble-tight shut off) and high  $C_v$  values. The Series 22/23 is crafted in a variety of materials such as PTFE, Stainless Steel, UHMWPE and special alloys to fit a wide range of customer requirements. As with all Bray's products, precision manufacturing and exceptional quality remain the keys to a proven record of long service life.

**NECK:** An extended neck design in all valve sizes allows for 2" of piping insulation and provides easy access for mounting actuators.

**FLANGE LOCATING HOLES:** Locating holes in the wafer version provide quick and precise alignment during valve installation eliminating disc interference with adjacent pipe I.D.

**BLOWOUT PROOF STEM:** A shoulder is machined into the upper stem. The stem and the disc are pressed together during assembly to become one part, thus the design is a positive stem-to-disc drive connection.

**DISC:** The PTFE disc has 1/8" (3 mm) minimum thickness of pure, virgin PTFE encapsulated over Stainless Steel.

**TOP STEM BUSHING:** A top stem bushing, retained by a stainless steel ring, is provided to absorb actuator side thrusts and is acetal as standard or PTFE as an option.

**UPPER STEM SEAL:** The upper stem seal serves to keep any environmental contaminants from entering the stem bore.

**BODY:** Bodies are two piece wafer or lug style and are epoxy coated. All bodies meet full ASME Class 150 and DIN 3840 pressure ratings for hydrostatic requirements.

**BEARINGS:** PTFE impregnated steel bearings provided for precision alignment of the upper and lower stem.

**PRIMARY SEAL:** The primary seal is achieved by an interference fit between the extra wide disc hubs and contoured seat.

**SEAT DESIGN:** The seat design reduces seating/unseating torque and, at the same time, reduces wear on the contacting parts. Curvatures machined into the inner seat area minimize contact forces between the disc and seat as the disc approaches, or opens from, the closed position. This unique seat geometry permits lower torques and reduces seat wear.

**SEAT ENERGIZER:** A resilient seat energizer extends completely around the seat, including the disc hub. This provides uniform force sufficient for bubble-tight shut off.

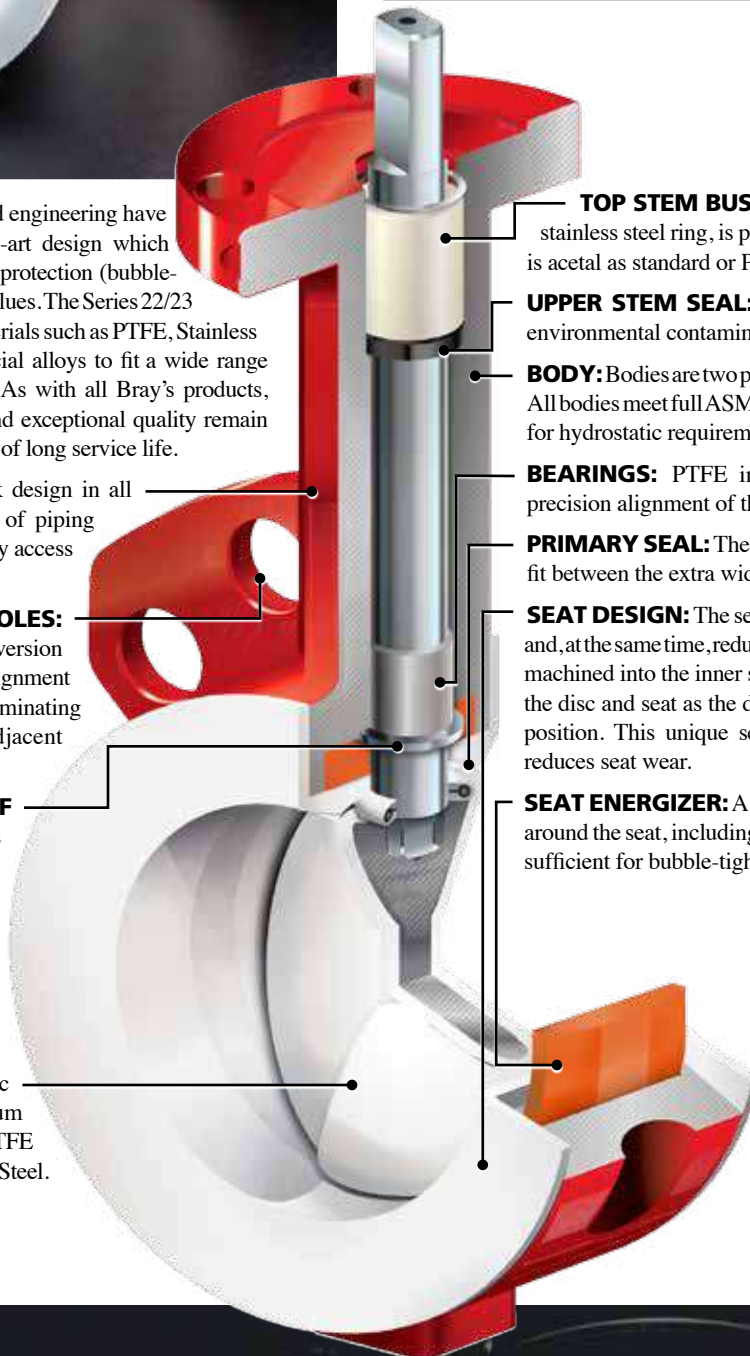

All Bray valves are pressure tested to 110% of rated pressure to assure bubble tight shutoff.

**SEAL CAPSULE:** (Secondary Seal) This seal capsule fully isolates the valve body and stem from the line media. The Seal Capsule is made of a virgin PTFE enclosing the internal energizer. The capsule fits into grooves machined in the upper and lower disc hubs. When compressed between the disc and seat during assembly, the capsule becomes energized, exerting both upward and downward pressure on disc and seat surfaces.

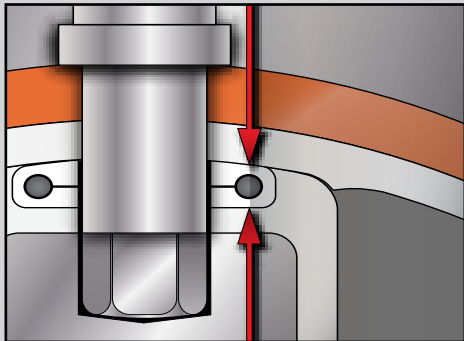

**BODY SEALS:** (Bidirectional): Reinforced PTFE gaskets are placed between the body halves. These seals eliminate contamination from external environmental conditions and potential leak path from the line media.

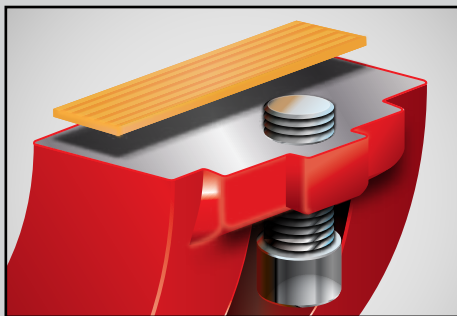

## ACCESSORIES

- **TAPPED PORT** can be provided in the body neck below the stem seal to connect leak detectors or instrumentation.
- **GROUNDING CABLE** is offered to protect against static charge build-up. The cable mounts to the valve body.



## STANDARD MATERIALS SELECTION

NAME	MATERIAL
<b>Body</b>	Ductile Iron
	Stainless Steel
	Carbon Steel
<b>Disc</b>	Stainless Steel
	PTFE molded over Stainless Steel
	UHMWPE molded over Stainless Steel
	Hastelloy®
	Titanium
<b>Upper Stem</b>	17-4 PH Stainless Steel
<b>Lower Stem</b>	17-4 PH Stainless Steel
<b>Seat</b>	PTFE
	Conductive PTFE
	UHMWPE
<b>Bushing</b>	Acetal
	PTFE
<b>Upper Stem Seal</b>	BUNA-N FKM*
<b>Seal Capsule (2)</b>	PTFE/FKM
<b>Bearing (2)</b>	PTFE / Steel
<b>Seat Energizer (2)</b>	Silicone FKM*
<b>Body Bolt (2)</b>	Stainless Steel
<b>Retainer</b>	Stainless Steel
<b>Body Seal (2)</b>	Reinforced PTFE
<b>ID Tag</b>	Stainless Steel

Material availability depends on valve size & series. Other materials are available. Please consult your local Bray representative for your specific application.

\*FKM is the ASTM D1418 designation for Fluorinated Hydrocarbon Elastomers (also called Fluoroelastomers).  
Hastelloy® is a registered trademark of Haynes International, Inc.

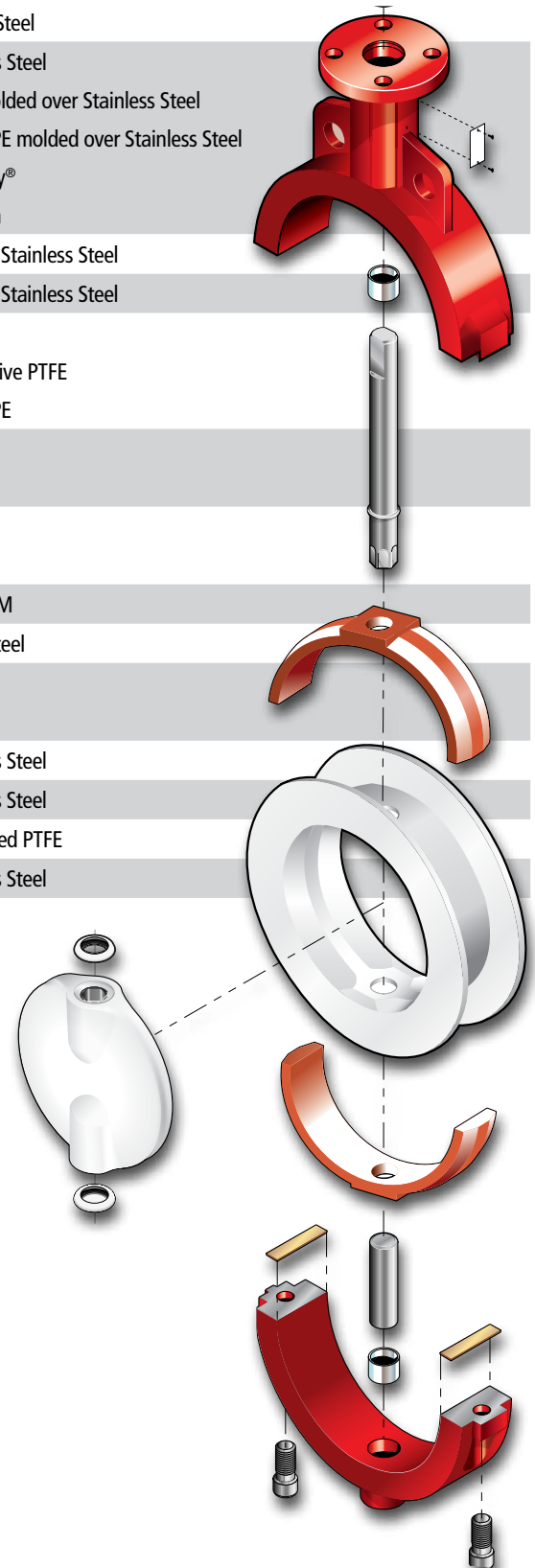

# SERIES 30/31 2"-20" (50mm-500mm)



## PRESSURE RATINGS

### BIDIRECTIONAL BUBBLE-TIGHT SHUT-OFF – Standard Disc\*

Downstream Flanges/Disc in Closed Position

S30/31 Standard Disc*	2-12" (50-300mm)	175 psi (12 Bar)
	14-20" (350-500mm)	150 psi (10.3 Bar)

### DEAD-END SERVICE – Lug Bodies/Standard Disc\*

No Downstream Flanges/Disc in Closed Position

S31	2-12" (50-300mm)	75 psi (5.2 Bar)
	14-20" (350-500mm)	50 psi (3.4 Bar)

**BODY:** 250 psi (17.2 Bar) CWP

\*For low pressure application, Bray offers a standard reduced disc diameter to decrease seating torques and extend seat life, thus increasing the valve's performance and reducing actuator costs.

## VELOCITY LIMITS For On/Off Services:

Fluids 30 ft/sec (9 m/s)    Gases 175 ft/sec (54 m/s)

High strength through-stem design allows easy disassembly and reduced disc to stem failure.

**PRIMARY & SECONDARY SEALS:** These seals prevent line media from coming in contact with the stem or body. *Primary Seal* is achieved by an interference fit of the molded seat flat with the disc hub. *Secondary Seal* is created because the stem diameter is greater than the diameter of the seat stem hole.

**STEM:** Precision double "D" disc to stem connection drives the disc without the need for screws or pins. The close tolerance, double "D" connection that drives the valve disc is an exclusive feature of the Bray valve. Disassembly of the Bray stem is just a matter of pulling the stem out of the disc.

**SEAT:** Bray's tongue and groove seat design lowers torque and provides complete isolation of flowing media from the body. The seat also features a molded O-ring which eliminates the use of flange gaskets.

**STEM RETAINING ASSEMBLY:** The stem is retained in the body by means of a unique Stainless Steel Spirolox® retaining ring, a thrust washer and two C-rings, manufactured from brass as standard, stainless steel upon request. The retaining ring may be easily removed with a standard hand tool. The stem retaining assembly prevents unintentional removal of the stem during field service.

**STEM BUSHING:** Non-corrosive, heavy duty acetal bushing absorbs actuator side thrust.

**STEM SEAL:** Double "U" cup seal design is self-adjusting and gives positive sealing in both directions.

**NECK:** Extended neck length allows for 2" of piping insulation and is easily accessible for mounting actuators.

**DISC:** Casting is spherically machined and hand polished to provide a bubble-tight shut off, minimum torque, and longer seat life.

**BODY:** One-piece wafer or lug style. Polyester coating for excellent corrosion resistance. Nylon 11 coating is available as an option.

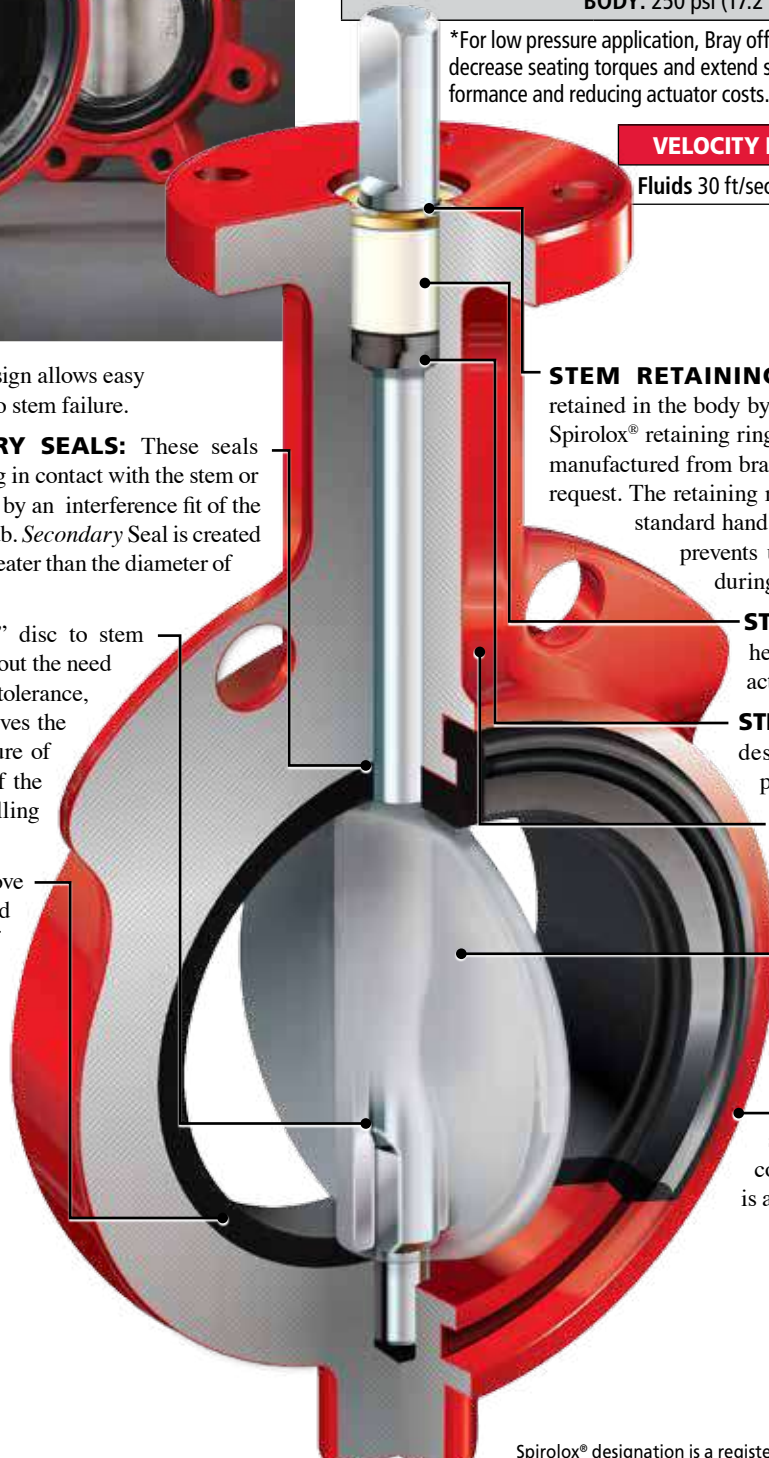

Spirolox® designation is a registered trademark of Kaydon Ring and Seal, Inc.

All Bray valves are pressure tested to 110% of rated pressure to assure bubble tight shutoff.



## SERIES 31H

2" - 20" (50mm-500mm)

Series 31H Lug valves are drilled and tapped to meet ASME Class 125/150 and PN16 flanges. Series 31H Valves will not be automated.

### PRESSURE RATINGS

BIDIRECTIONAL BUBBLE-TIGHT SHUT OFF & DEAD-END SERVICE	
2-20" (50-500mm)	250 psi (17.2 Bar)
BODY: 250 psi (17.2 Bar) CWP	

### VELOCITY LIMITS For On/Off Services:

Fluids 30 ft/sec (9 m/s)	Gases 175 ft/sec (54 m/s)
--------------------------	---------------------------

### STANDARD MATERIALS SELECTION 31H

<b>Body</b>	Cast Iron Ductile Iron
<b>Disc</b>	Aluminum Bronze Nylon 11 Coated Ductile Iron 316 Stainless Steel
<b>Stem</b>	416 Stainless Steel
<b>Seat</b>	Bonded EPDM Bonded BUNA-N

Material availability depends on valve size & series. Other materials are available. Please consult your local Bray representative for your specific application.

### STANDARD MATERIALS SELECTION S30/31

NAME	MATERIAL
<b>Body</b>	Cast Iron
	Ductile Iron
	Carbon Steel
	Aluminum
<b>Disc</b>	Aluminum Bronze
	Coated Ductile Iron
	Nylon 11 Coated Ductile Iron
	Halar® Coated Ductile Iron
	304 Stainless Steel
	316 Stainless Steel
	Duplex Stainless Steel
	Super Duplex Stainless Steel
	Hastelloy®
<b>Stem</b>	416 Stainless Steel
	304 Stainless Steel
	316 Stainless Steel
	Monel K500
<b>Seat</b>	BUNA-N – Food Grade
	EPDM – Food Grade
	FKM*
	White BUNA-N – Food Grade
	Bonded EPDM
	Bonded BUNA-N

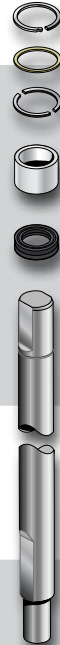

Material availability depends on valve size & series. Other materials are available. Please consult your local Bray representative for your specific application.

\*FKM is the ASTM D1418 designation for Fluorinated Hydrocarbon Elastomers (also called Fluoroelastomers).  
Hastelloy® is a registered trademark of Haynes International, Inc.  
Halar® is a registered trademark of Ausimont U.S.A., Inc.



# SERIES 31U 2"-20" (50mm-500mm)



## PRESSURE RATINGS

### BIDIRECTIONAL BUBBLE-TIGHT SHUT-OFF & DEAD-END SERVICE

2-20" (50-500mm)

285 psi (20 Bar)

**BODY:** 285 psi (20 Bar) CWP

## VELOCITY LIMITS For On/Off Services:

**Fluids** 30 ft/sec (9 m/s)

**Gases** 175 ft/sec (54 m/s)

Bray Controls offers our high quality, high pressure resilient-seated butterfly valves to meet the requirements of today's industrial/marine markets. This valve is specifically designed for onshore and offshore fire protection where the applicable certification is D.O.T. 54 (UK Department of Trade). The series 31U is designed to withstand high line velocities and pressure drops through the valve.

**NECK:** Extended neck length allows for piping insulation and is easily accessible for mounting operators.

**BODY:** One-piece lugged style flange configuration, with a choice of Polyester Coated Ductile Iron/Carbon Steel or uncoated Nickel Aluminium Bronze. All bodies can be drilled to be compatible with ASME 125/150, PN10/16 or other international flange standards.

**STEM:** High Strength upper and lower stem incorporate a close tolerance double 'D' disk drive connection. This eliminates stem retention components being exposed to the line media and allows for easy disassembly for maintenance purposes, unlike disc screws and taper pins.

**DISC:** Casting is spherically machined and hand polished to provide bubble-tight shut-off with minimum torque and an extended seat life.

**MODULAR DESIGN:** All Bray manual gear operators, electric and pneumatic actuators mount directly to the S31U, with no brackets required.

**STEM BUSHING:** Non-corrosive heavy duty acetal bushing absorbs actuator side thrust.

**STEM SEAL:** Patented stem retaining ring and C-rings prevent unintentional removal of the stem during field service.

**SEAT DESIGN:** Bray's bonded tongue and groove resilient seat design offers lower torque than many valves on the market today and provides complete isolation of flowing media from all valve components (excluding the disc) by a totally encasing design. The seat features a molded tangential O-ring eliminating any need for flange gaskets.

**PRIMARY & SECONDARY SEALS:** These seals prevent line media from coming in contact with the stem or body. *Primary Seal* is achieved by an interference fit of the molded seat flat with the disc hub. *Secondary Seal* is created because the stem diameter is greater than the diameter of the seat stem hole.

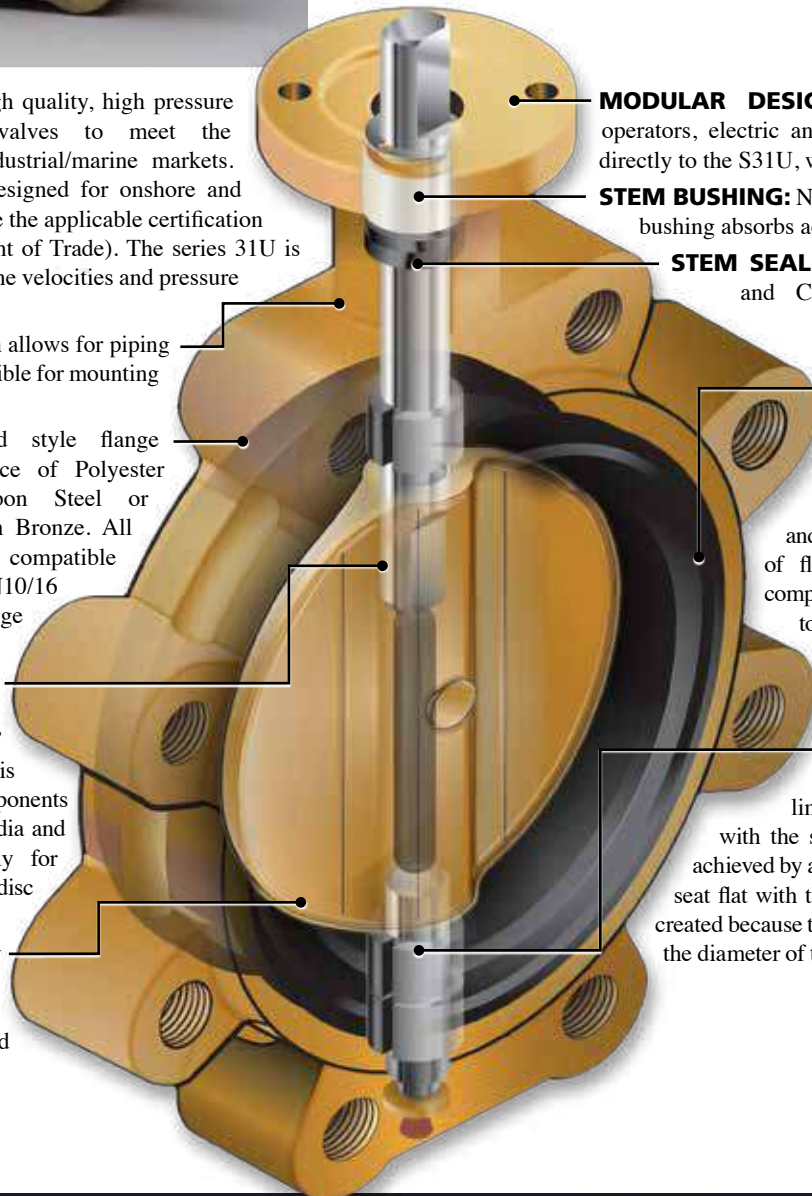

All Bray valves are pressure tested to 110% of rated pressure to assure bubble tight shutoff.

### STANDARD MATERIALS SELECTION

NAME	MATERIAL
Body	Carbon Steel
	Nickel Aluminum Bronze
	Ductile Iron
Disc	316 Stainless Steel
	Monel K500
	Nickel Aluminum Bronze
Stem	17-4PH Stainless Steel
	Monel K500
	Stainless Steel
Seat	Bonded BUNA-N

Material availability depends on valve size & series. Other materials are available. Please consult your local Bray representative for your specific application.

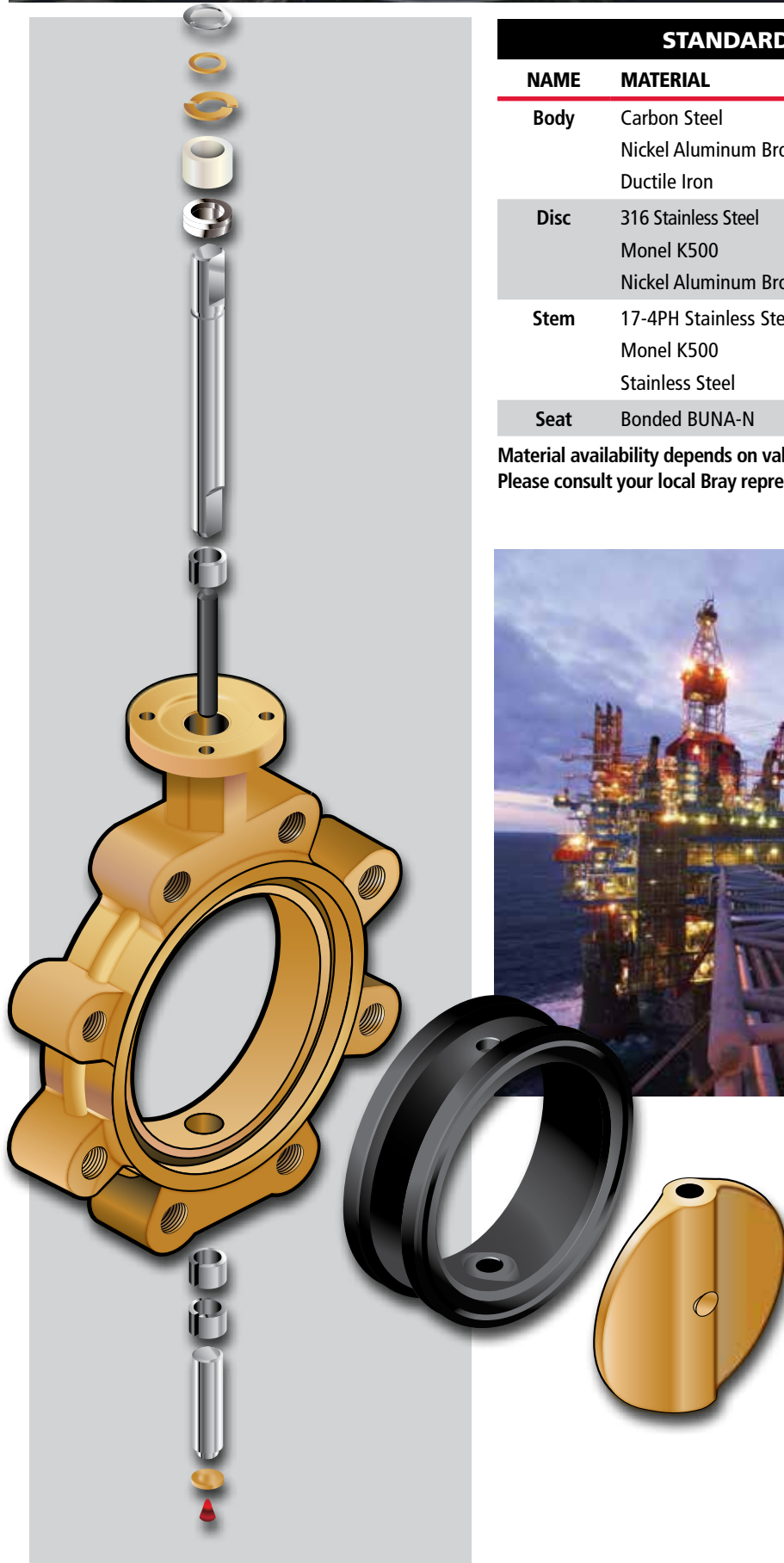

# SERIES 3A 2"-20" (50mm-500mm)



## PRESSURE RATINGS

### BIDIRECTIONAL BUBBLE-TIGHT SHUT-OFF & DEAD-END SERVICE

2-12" (50-300mm)	Standard Disc	175 psi (12 Bar)
	Reduced Disc	50 psi (3.4 Bar)
14-20" (350-500mm)	Standard Disc	150 psi (10.3 Bar)
	Reduced Disc	50 psi (3.4 Bar)

**BODY:** 250 psi (17.2 Bar) CWP

## VELOCITY LIMITS For On/Off Services:

**Fluids** 30 ft/sec (9 m/s)

**Gases** 175 ft/sec (54 m/s)

Bray's Series 3A/3AH valve is a Double Flanged design which can be used for dead-end service. A major design advantage of Bray valve product lines is international compatibility. The same valve is compatible with most world flange standards—ASME Class 125/150, BS 10 Tables D and E, BS 4504 NP 10/16, DIN ND 10/16, AS 2129 and JIS10. In addition, the valves are designed to comply with ISO 5752 - Table 1 (EN 558 Table 14) face-to-face and ISO 5211 actuator mounting flanges. Therefore, one valve design can be used in many different world markets.

**STEM RETAINING ASSEMBLY:** The stem is retained in the body by means of a unique Stainless Steel Spirolox® retaining ring, a thrust washer and two C-rings, manufactured from brass as standard, stainless steel upon request. The retaining ring may be easily removed with a standard hand tool. The stem retaining assembly prevents unintentional removal of the stem during field service.

**STEM BUSHING:** Non-corrosive, heavy duty acetal bushing absorbs actuator side thrusts.

**STEM SEAL:** Double "U" cup seal design is self-adjusting, gives positive sealing in both directions, and prevents external substances from entering the stem bore.

**EXTENDED NECK:** Extended neck length allows for 2" of piping insulation and is easily accessible for mounting actuators.

**PRIMARY & SECONDARY SEALS:** These seals prevent line media from coming in contact with the stem or body. *Primary Seal* is achieved by an interference fit of the molded seat flat with the disc hub. *Secondary Seal* is created because the stem diameter is greater than the diameter of the seat stem hole.

Spirolox® designation is a registered trademark of Kaydon Ring and Seal, Inc.

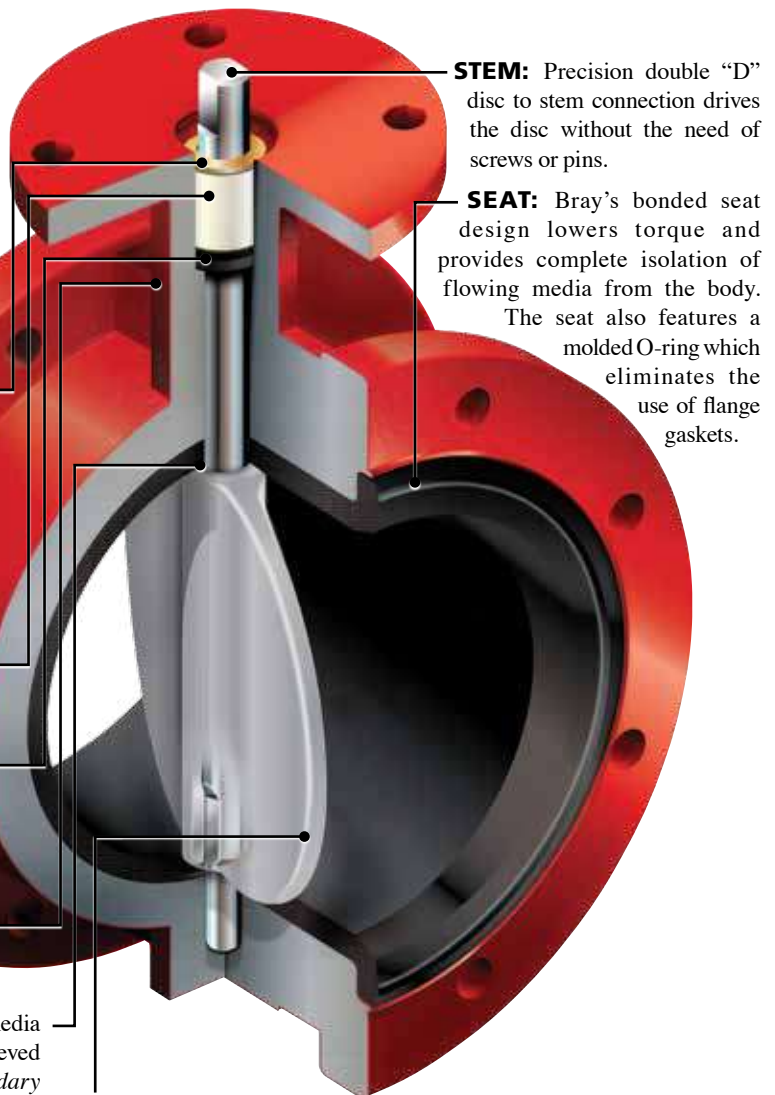

**STEM:** Precision double "D" disc to stem connection drives the disc without the need of screws or pins.

**SEAT:** Bray's bonded seat design lowers torque and provides complete isolation of flowing media from the body.

The seat also features a molded O-ring which eliminates the use of flange gaskets.

**DISC:** Spherically machined and hand polished to provide a bubble-tight shut off, minimum torque, and longer seat life.



All Bray valves are pressure tested to 110% of rated pressure to assure bubble tight shutoff.



**HIGH PRESSURE  
RESILIENT SEATED**

## SERIES 3AH

Series 3AH double flanged valves are drilled and tapped to meet ASME Class 125/150 and PN16 flanges. Series 3AH Valves will not be automated.

### PRESSURE RATINGS

**BIDIRECTIONAL BUBBLE-TIGHT SHUT-OFF  
& DEAD-END SERVICE**

2-20" (50-500mm)	250 psi (17.2 Bar)
------------------	--------------------

**BODY: 250 psi (17.2 Bar) CWP**

### VELOCITY LIMITS For On/Off Services:

Fluids 30 ft/sec (9 m/s)	Gases 175 ft/sec (54 m/s)
--------------------------	---------------------------

### STANDARD MATERIALS SELECTION 3AH

**Body** Ductile Iron

**Disc** Aluminum Bronze  
Nylon 11 Coated Ductile Iron  
316 Stainless Steel

**Stem** 416 Stainless Steel

**Seat** Bonded EPDM  
Bonded BUNA-N

Material availability depends on valve size & series. Other materials are available. Please consult your local Bray representative for your specific application.

### STANDARD MATERIALS SELECTION – Series 3A

NAME	MATERIAL
------	----------

<b>Body</b>	Cast Iron
	Ductile Iron
	Carbon Steel

<b>Disc</b>	Aluminum Bronze
	Coated Ductile Iron
	Nylon 11 Coated Ductile Iron
	Halar® Coated Ductile Iron
	304 Stainless Steel
	316 Stainless Steel
	Duplex Stainless Steel
	Super Duplex Stainless Steel
Hastelloy®	

<b>Stem</b>	416 Stainless Steel
	304 Stainless Steel
	316 Stainless Steel
	Monel K500

<b>Seat</b>	Bonded EPDM
	Bonded BUNA-N
	Bonded FKM*



Material availability depends on valve size & series. Other materials are available. Please consult your local Bray representative for your specific application.

\*FKM is the ASTM D1418 designation for Fluorinated Hydrocarbon Elastomers (also called Fluoroelastomers). Hastelloy® is a registered trademark of Haynes International, Inc. Halar® is a registered trademark of Ausimont U.S.A., Inc.

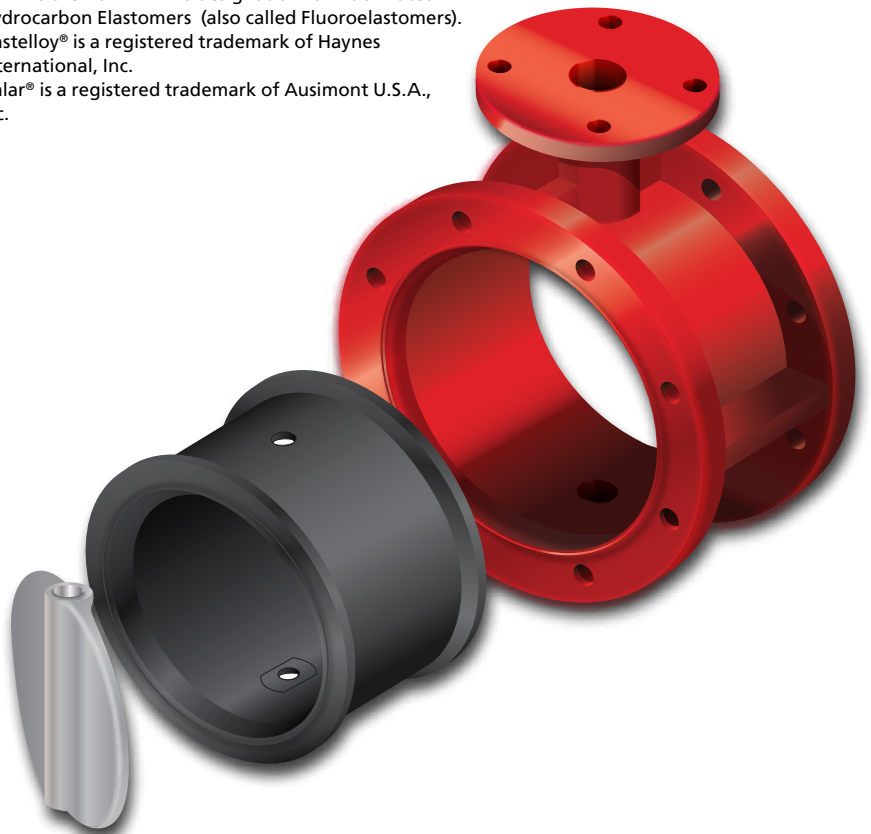

# SERIES 32/33 & 35/36



## PRESSURE RATINGS

BIDIRECTIONAL BUBBLE-TIGHT SHUT-OFF Downstream Flanges/Disc in Closed Position		
Series 32 (Wafer)	22-36" (550-900mm)	75 psi (5.2 Bar)
Series 33 (Wafer)	22-36" (550-900mm)	150 psi (10.3 Bar)
Series 35 (Full Flanged)	22-120" (550-3000mm)	75 psi (5.2 Bar)
Series 36 (Full Flanged)	22-120" (550-3000mm)	to 150 psi (10.3 Bar)
DEAD-END SERVICE No Downstream Flanges/Disc in Closed Position		
Series 35 (Full Flanged)	22-120" (550-3000mm)	30 psi (2.1 Bar)
Series 36 (Full Flanged)	22-120" (550-3000mm)	50 psi (3.4 Bar)
<b>BODY : 250 psi (17.2 Bar) CWP</b>		

## VELOCITY LIMITS For On/Off Services:

<b>Fluids</b> 30 ft/sec (9 m/s)	<b>Gases</b> 175 ft/sec (54 m/s)
---------------------------------	----------------------------------

This valve series has many of the design features and benefits of the smaller Bray valves, such as high Cv ratings, minimum parts exposed to the line media, greater reliability and a proven record of long service life.

**BODY:** One piece full flanged style. All bodies are drilled to be compatible with ASME 125/150, PN 10 or other international flange standards. Wafer style bodies are also available.

**DISC:** High strength discs are first cast, the sealing edges are spherically machined then either hand polished or the entire disc is Nylon 11 coated. The symmetrical disc profile increases  $C_v$  values, reduces turbulence and increases pressure recovery.

**SEAT:** The replaceable tongue and groove seat to body retention method is the most advanced design in the industry. Molded O-ring eliminates the requirement of flange gaskets. The seat isolates the valve body and stem from line media and has been specifically designed to seal with slip-on or weld-neck flanges.

**BLOW-OUT PROOF STEM:** A retaining ring, installed between the machined stem groove and gland retainer step, provides full retention of the stem in the unlikely event of internal stem failure.

### ADJUSTABLE PACKING SYSTEM:

Design allows for field adjustment of stem packing without removing manual operators or power actuators. The advanced, self-adjusting V-Type stem packing prevents external substances from entering the upper stem bore.

### PRIMARY & SECONDARY SEALS:

These seals prevent line media from coming in contact with the stem or body. *Primary Seal* is achieved by an interference fit of the molded seat flat with the disc hub. *Secondary Seal* is created because the stem diameter is greater than the diameter of the seat stem hole.

### STEM BEARINGS:

To absorb actuator side thrust and minimize bearing friction torque, upper and lower heavy wall sleeve bearings are utilized.

**VERTICAL THRUST BEARING:** A bronze vertical thrust bearing eliminates disc displacement due to the weight of the stem and disc.

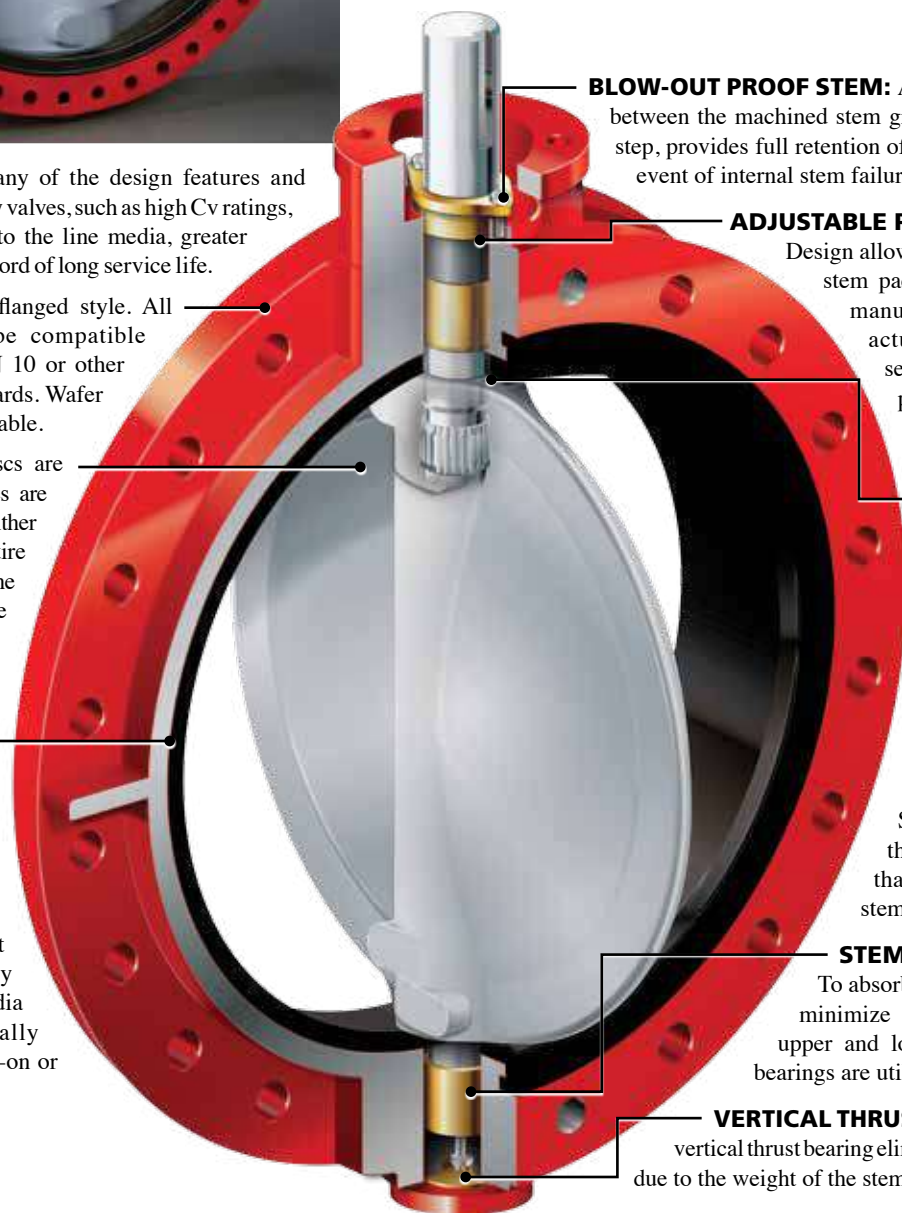

### DISC - STEM CONNECTIONS

**Spline:** male splines in the stem and female in the disc.

Standard Sizes 22" – 48" (550mm–1200mm)  
Selected Sizes 54" – 120" (1400mm–3000mm)

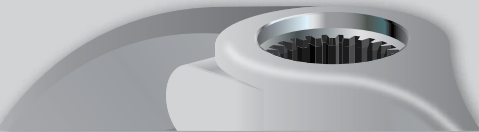
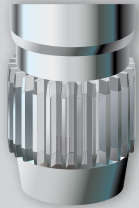

**Double Keyed:** keyways machined into disc matching keys in the stem  
Selected Sizes 54" – 120" (1400mm–3000mm)

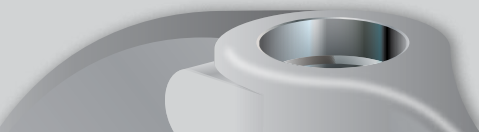

### STANDARD MATERIALS SELECTION

NAME	MATERIAL
Body	Cast Iron
	Ductile Iron
	Carbon Steel
	316 Stainless Steel
Disc	Nylon 11 Coated Ductile Iron
	316 Stainless Steel
	304 Stainless Steel
	Aluminum Bronze
	Monel®
	Hastelloy®
	Duplex Stainless Steel
	Super Austenitic Stainless Steel
Stem	416 Stainless Steel
	304 Stainless Steel
	316 Stainless Steel
	17-4 PH Stainless Steel
	Monel®
	Super Austenitic Stainless Steel
Seat Valves 54" (1400 mm) and larger are provided with bonded seats	EPDM
	BUNA-N
	FKM*
Packing	BUNA-N
Bearings	Lubricant Impregnated Bronze
	PTFE Encapsulated Stainless Steel
Thrust Bearing	Bronze

Material availability depends on valve size & series. Other materials are available. Please consult your local Bray representative for your specific application.

\*FKM is the ASTM D1418 designation for Fluorinated Hydrocarbon Elastomers (also called Fluoroelastomers). Hastelloy® is a registered trademark of Haynes International, Inc. Halar® is a registered trademark of Ausimont U.S.A., Inc. Monel® is a registered trademark of The International Nickel Company, Inc.

### BRAY TONGUE & GROOVE SEATS

*Competitor Strip Seats* expose the body, stem and disc stem hole to the line media, thus causing premature failure due to corrosion. Material costs are significantly increased for highly corrosive applications.

*Bray's Seat* isolates the line media from contacting the body and stem, thus increasing service life and therefore lowering costs over the life of the valve.

Competitor's Seat

Bray's Seat



# SERIES 36H 22"-60" (550mm-1500mm)



Bray Controls is proud to offer a line of superior quality, high pressure manual butterfly valves that meet many of today's requirements in the process industry. **Note: Series 36H valves will not be automated.** Series 36H large diameter, double flanged valves are rated for 232 psi (16 Bar) bidirectional dead end service. Series 36H double flanged valves are drilled and tapped to meet ASME Class 125/150 and PN10 flanges.

**DISC:** Disc edge sealing surface is spherically machined and hand polished to provide a bubble-tight shutoff with minimum torque and extended seat cycle life.

**SEAT:** Tongue and groove seat design, bonded to the body, is designed to seal with slip-on or weld-neck flanges. Seat totally encases the valve interior to isolate the line media from the body. Molded seat O-ring provides seal between valve and pipe flanges. Flange gaskets should not be used with this valve.

**PRIMARY & SECONDARY SEALS:** These seals prevent line media from coming in contact with the stem or body. *Primary Seal* is achieved by an interference fit of the molded seat flat with the disc hub. *Secondary Seal* is created because the stem diameter is greater than the diameter of the seat stem hole.

**STEM:** Stem completely isolated from the flowing media.

**Note: Disc-stem connection on the Series 36H is a taper-pin connection.**

All Bray valves are pressure tested to 110% of rated pressure to assure bubble tight shutoff.

## PRESSURE RATINGS

<b>BIDIRECTIONAL BUBBLE-TIGHT SHUT-OFF</b> Downstream Flanges/Disc in Closed Position	
22-60" (550-1500mm)	232 psi (16 Bar)
<b>DEAD-END SERVICE</b> No Downstream Flanges/Disc in Closed Position	
22-60" (550-1500mm)	150 psi (10.3 Bar)
<b>BODY:</b> 250 psi (17.2 Bar) CWP	

## VELOCITY LIMITS For On/Off Services:

Fluids 30 ft/sec (9 m/s)	Gases 175 ft/sec (54 m/s)
--------------------------	---------------------------

## STANDARD MATERIALS SELECTION

NAME	MATERIAL
Body	Ductile Iron
Disc	Nylon 11 Coated, Ductile Iron Aluminum Bronze 316 Stainless Steel
Stem	17-4 PH Stainless Steel
Seat	Bonded EPDM Bonded BUNA-N
Packing	BUNA-N
Bearings	Lubricant Impregnated Bronze
Thrust Bearing	Bronze

Material availability depends on valve size & series. Other materials are available. Please consult your local Bray representative for your specific application.



# 32" -60" (800mm-1500mm) **SERIES 35F**

## PRESSURE RATINGS

<b>BIDIRECTIONAL BUBBLE-TIGHT SHUT-OFF</b> Downstream Flanges/Disc in Closed Position	
32-60" (800-1500mm)	75 psi (5.2 Bar)
<b>DEAD-END SERVICE</b> No Downstream Flanges/Disc in Closed Position	
32-60" (800-1500mm)	30 psi (2.1 Bar)
<b>BODY:</b> 250 psi (17.2 Bar) CWP	

## VELOCITY LIMITS For On/Off Services:

Fluids 30 ft/sec (9 m/s)	Gases 175 ft/sec (54 m/s)
--------------------------	---------------------------

## STANDARD MATERIALS SELECTION

NAME	MATERIAL
Body	Cast Iron
	Ductile Iron
Disc	Hastelloy®
	Duplex Stainless Steel
	Super Austenitic Stainless Steel
Stem	304 Stainless Steel
	316 Stainless Steel
Seat	Bonded EPDM
	Bonded BUNA-N
Packing	BUNA-N
Bearings	Bronze
Thrust Bearing	Bronze

Material availability depends on valve size & series. Other materials are available. Please consult your local Bray representative for your specific application.

Hastelloy® is a registered trademark of Haynes International, Inc.



Bray Series 35F large diameter butterfly valves are designed specifically for high chloride services. Bray has carefully selected valve materials and features that optimize performance without sacrificing system efficiency. Series 35F valves offer rugged reliability in a light weight design.

**BODIES:** One piece double flanged style. All bodies are drilled to be compatible with ASME 125, PN 16 and other international flange standards.

**BLOW-OUT PROOF STEM:** Retention system secures the stem in the unlikely event of internal failure.

**PRIMARY & SECONDARY SEALS:** These seals prevent line media from coming in contact with the stem or body. *Primary Seal* is achieved by an interference fit of the molded seat flat with the disc hub. *Secondary Seal* is created because the stem diameter is greater than the diameter of the seat stem hole.

**ADJUSTABLE PACKING SYSTEM:** Design allows for field adjustment of stem packing without removing manual operators or power actuators. The advanced, self-adjusting V-Type stem packing prevents external substances from entering the upper stem bore.

**INTERNAL DISC/STEM CONNECTIONS:** Protect stem components by eliminating external disc screws or taper pins.

**THIN PROFILE DISC:** Provides a higher  $C_v$  and greater pressure recovery than typical large diameter valves resulting in lower pressure drops.

**All Bray valves are pressure tested to 110% of rated pressure to assure bubble tight shutoff.**

# ACTUATORS & ACCESSORIES



## SERIES 70 *ELECTRIC*

Torque	300 to 18,000 lb-ins (34-2030 Nm)
Voltage	VAC: 24, 120, 220 VDC: 12, 24
Standard Enclosure	NEMA 4, 4X
Explosion Proof:	NEMA 4, 4X, 7 and 9

**The Series 70 is a low profile, compact and powerful actuator with customer-friendly features.**

- Manual declutchable handwheel
- Local high visibility position indicator
- Digital interface available
- Optional microprocessor based modulating control



## SERIES 92/93 *PNEUMATIC*

**Bray pneumatic actuators are rack and pinion, opposed-piston actuators available in two versions: double acting and spring return.**

- Maximum pressure rating of 140 psi (9.7 bar) and a temperature range of -20°F (-29°C) to +200°F (+95°C)
- Two independently adjustable travel stop screws and a cam on the output shaft to permit precise bidirectional adjustment of movement in both the open and closed positions for quarter turn valves (+5° to -5° limit adjustment)
- Integral porting
- Standard units have anodized aluminum bodies with polyester coated end caps.
- Special coatings and materials available for corrosive environments
- NAMUR accessory compatible



**SS ACTUATOR**



**TRAVEL STOP**



**SPRING RETURN**

# ACTUATORS & ACCESSORIES



**SERIES 50** - Valve Status Monitors

- 10 amps at 125 or 250 volts AC
- Internal travel switches that are prewired to a terminal block



**SERIES 52** - Valve Status Monitors

- ProxSensor provides 2 proximity sensors in one fully sealed, compact enclosure.
- AC, DC, Intrinsically Safe and BUS Network versions are offered.



**SERIES 63** - 3 & 4 way solenoids

- Waterproof (NEMA 4,4X) and explosion proof (NEMA 7,9) housings are standard
- NPT and IP65 DIN connections are offered with both single and dual coils



**SERIES 6A**

Electro-Pneumatic Positioners

- Precise, microprocessor driven flow control and advanced communication
- For use with either double or single acting actuators



**Serial Bus Communication**

- Bray offers several products featuring serial bus communication.
- Multiple protocols available. Consult your local Bray representative.

## Manual Operators



**SERIES 1** - Handle & Notch Plate



**SERIES 4** - Gear Operator



**SERIES 5** - Dec clutchable Gear Operator

## **BRAY CONTROLS**

---

### **USA**

Houston, TX. +281.894.5454

### **ARGENTINA**

Buenos Aires + 54.11.4362.0666

### **BENELUX**

Heerhugowaard +31.72.572.1410

### **BRAZIL**

Paulinia SP-Brazil +55.19.3844.6161

### **CANADA**

Montréal +514.344.2729

### **CHILE**

Santiago +56.2739.2966

### **CHINA**

Hangzhou, Zhejiang +86.571.828.52200

### **GERMANY**

Krefeld +49.2151.53360

### **INDIA**

Gujarat +91.265.2633868

### **MEXICO**

Zapopan, Jalisco, +52.33.3836.4460

### **PACIFIC**

Melbourne, Australia +613.8541.2555

### **PERU**

Lima +511.251.0251

### **POLAND**

Oświęcim +48.33.842.1968

### **UNITED KINGDOM**

Inchinnan +44.141.812.5199

### **VIETNAM**

Ho Chi Minh City +84.8.3742.3428

## **FLOW-TEK**

---

### **USA**

Houston, TX +832.912.2300

### **CHINA**

Hangzhou, Zhejiang +86.571.828.52200

## **RITEPRO**

---

### **CANADA**

Montréal +514.324.8900

### **CHINA**

Hangzhou, Zhejiang +86.571.828.52200



▲ **WORLD HEADQUARTERS - BRAY INTERNATIONAL , INC. - USA**

# **Global Manufacturing, Service Around the Corner**

To serve you locally, each region maintains a  
factory certified sales and service network  
for all Bray International products.



▼ **BRAY CONTROLS - CHINA - Office & Manufacturing**

All statements, technical information, and recommendations in this bulletin are for general use only. Consult Bray representatives or factory for the specific requirements and material selection for your intended application. The right to change or modify product design or product without prior notice is reserved. Patents issued and applied for worldwide.

Bray® is a registered trademark of  
BRAY INTERNATIONAL, Inc.  
© 2011 Bray International. All rights reserved.

B-1050\_EL\_Resilient\_2014-08

# **Bray** CONTROLS

A Division of BRAY INTERNATIONAL, Inc.  
13333 Westland East Blvd. Houston, Texas 77041  
281.894.5454 FAX 281.894.9499 www.bray.com